

MEET

MILO PANEL

FERMAX

INSTALLATION MANUAL



CONGRATULATIONS FOR BUYING A QUALITY PRODUCT!

Fermax Electrónica develops and manufactures premium equipment that meets the highest design and technology standards. We hope you will enjoy all its functions.

Technical publication for information purposes edited by FERMAX ELECTRÓNICA S.A.U.

FERMAX ELECTRÓNICA applies a continuous improvement policy, therefore it reserves the right to modify the contents of this document, as well as the product features hereof at any time and without prior notice. Any modification will be reflected in subsequent editions of this document.







This product is protected with the following patents and utility models:

PATENTS: US 9215410, US 9762852, BE1023440, AU2014203706.

UTILITY MODELS: ES1187384U, ES1141495U, FR3038192, DE202016000632U1, CN205987229(U).

Code 970134lh V07_22

INDEX

	1. DESCRIPTION	4
<hr/>		
	2. WEB BROWSER PROGRAMMING	5
	2.1. Device	6
	2.2. General	6
	2.3. Network configuration	8
	2.4. Access	9
	2.5. Face recognition	10
	2.6. Ip camera	11
	2.7. Sip	11
	2.8. Sip trunk	13
	2.9. Sip call	13
	2.10. Advanced	15
	2.11. Pincode	16
	2.12. Restore	16
<hr/>		
	3. OPERATION	18
<hr/>		
	4. INSTALLATION	21
	4.1. Flush box installation	21
	4.2. Installation Guide Diagram	21
	4.3. Connectors	22
	4.4. Basic diagrams	23
	4.5. Installation of the 4 RELAY MODULE REF. 1491	23
	4.6. Diagram installation of the GUEST CODE Module Ref. 1494	23
	4.7. Diagram installation of the lift control system	24
<hr/>		
	5. TECHNICAL SPECIFICATIONS	25
<hr/>		
	6. ANNEX	26
	6.1. Firmware updates	26
	6.2. Regulations	
	6.3. Outdoor panel video streaming	26
<hr/>		

It includes installation and programming instructions.



1 DESCRIPTION

This document is the Installer Manual for:

- MILO DIGITAL PANEL Ref. 9531 V 03.00.
- MILO TACTIL DIGITAL PANEL Ref. 9532 V03.00.

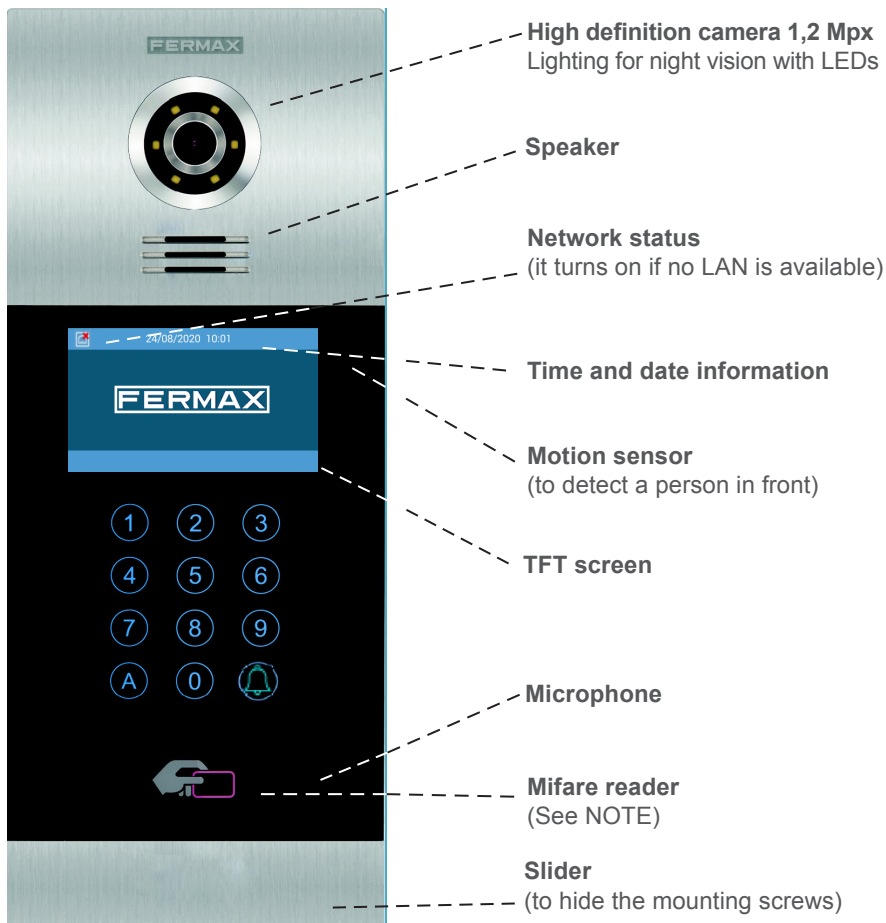

NOTE:

Residents can access to their corresponding entrance by passing their authorized Mifare card. The door will open and release the lock.

The Mifare identifier data must be added through FERMAX MEET MANAGEMENT software. Maximum 100.000 Mifare cards.

By means of their WIEGAND connection (output) it is possible to integrate this Mifare Card reader in third party Access Control Systems. It is also possible to integrate third party readers using WIEGAND protocol with the KIN panel.



WEB BROWSER PROGRAMMING

For programming of the MILO panel, access is required through a PC via a web browser. Preferably use Chrome browser.

The PC must be connected to the same LAN as the panel and configured with an IP address in the same range. The MILO panel default IP address is 10.1.0.1.

Type the IP address of the panel in the address bar of the browser. An identification form will appear.

Sign in

http://10.1.0.1
Your connection to this site is not private

Username

Password

The default identification data are:

- **User name:** admin
- **Password:** 123456

A form will appear with the different programming sections:

MEET VIDEO DOOR ENTRY SYSTEM

- DEVICE
- GENERAL
- NETWORK
- ACCESS
- FACE RECOG.
- IP CAMERA
- SIP
- SIP TRUNK
- SIP CALL
- ADVANCED
- PINCODE
- RESTORE

DEVICE INFO

FERMAX MEET PANEL
 FIRMWARE: V03.00
 DEVICE: BLOCK PANEL 016-01
 SERIAL NO.: 77FA-0072-7689
 MAC: BC:F8:11:01:15:56
 IP: 200.200.200.73
 COPYRIGHT © FERMAX ELECTRONICA S.A.U
www.fermax.com

PROGRAMMING
SECTIONS

2.1. DEVICE

The section DEVICE provides some technical information regarding the equipment, as a reference.

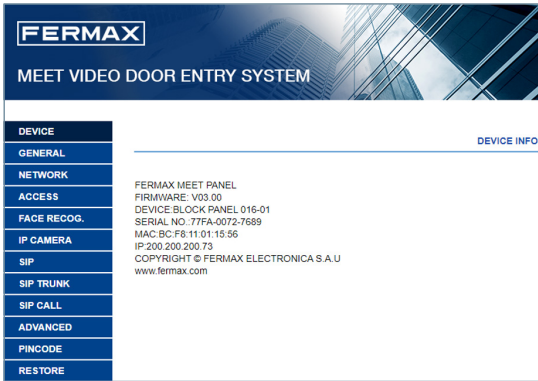

- **FERMAX MEET PANEL:** Device type.
- **FIRMWARE:** Version of the installed firmware.
- **DEVICE:** Type and panel number.
- **Nº DE SERIE:** Número único de identificación de la placa.
- **MAC:** Panel MAC number.
- **IP:** IP address assigned to the panel.

2.2. GENERAL

The section GENERAL allows the configuration of the identification parameters of the MILO panel within the installation and allows time-date configuration.

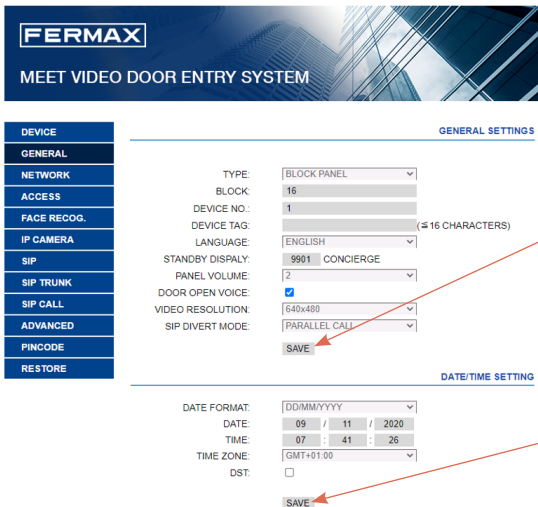

TYPE: Select the identification parameter of the panel. There are some other parameters related, depending on TYPE selection.

General Entrance Panel

Panel installed in one of the main entrances to a condominium

DEVICE NO.:	<input type="text" value="1"/>
TYPE:	<input type="text" value="G.E. PANEL"/>

- **DEVICE NUMBER:** Number assigned to the general entrance where this panel is installed (1-9000).
In the case that there is one entrance only, leave the default value 1.
- **DEVICE TAG:** Text to be shown in the monitor and guard unit.

Block Panel Entrance

Panel installed in a single building or in a block of a condominium

BLOCK:	1
DEVICE NO.:	1
TYPE:	BLOCK PANEL

- **BLOCK:** Number assigned to the block where the panel has been installed (1-999). In the case of individual blocks, let the default value: 1.
- **DEVICE NUMBER:** Number assigned to the block entrance where this panel is installed (1-99). In the case that there is one entrance only, leave the default value: 1.
- **DEVICE TAG:** Text to be shown in the monitor and guard unit.

LANGUAGE: : Select the desired language in the dropdown options.

Default option is ENGLISH.
Refresh the webpage after changing the language

STANDBY DISPLAY: The number of the concierge to be shown in the panel. This is the number that users have to dial for contacting the concierge.
Concierge number would be between 9901 (default value) and 9998, depending on the installation.

PANEL VOLUME: Select the desired value between 1 and 5. Default option is 4
The conversation volume is common for uplink and downlink.

DOOR OPEN VOICE: Enables or disables the speech when door lock is released. If the speech is disabled, no speech in the panel will sound when the lock is released. Enabled by default.

VIDEO RESOLUTION: To fit the different types of monitors. The default value 640×480

SIP DIVERT MODE: This function is available for the device of sip call list. Please refer to SIP section for further details.

PARALLEL CALL: When the panel calls the resident, the monitor and the call divert APP rings at the same time. Once one terminal answers the call the other one stops ringing.

SEQUENTIAL CALL: When the panel calls the resident, the monitor will ring 30s if no answer, the call divert APP will start to ring.

DATE FORMAT: Format to show the date information in the screen.

DATE: Setting date manually (See note below).

TIME: Setting time manually (See NOTE below).

TIME ZONE: Setting the time zone of panel. Select local time zone and save.

DAYLIGHT SAVING TIME: Shall be enabled for DST periods and disabled for wintertime.

NOTES:

If the installation has FERMAX MANAGEMENT SOFTWARE, the date and time of panel will synchronize automatically with the management software. If the panel has access to internet, the date and time of panel will also synchronize with internet time server.

If the installation has no FERMAX MANAGEMENT SOFTWARE the installer can set date, time and time zone manually. Do not use the GMT (TIME ZONE) adjustment in this case. GMT is usable only when the time is automatically taken from internet or FERMAX MANAGEMENT SOFTWARE.

Date and time cannot be saved after power loss unless there were internet or management software in the installation. However, the time zone, date format and daylight-saving time can be saved anyway.

Pay attention to the SAVE button related to panel settings or date/time settings since are different and independent.

2.3 NETWORK CONFIGURATION

Allows the configuration of the different parameters of the LAN network

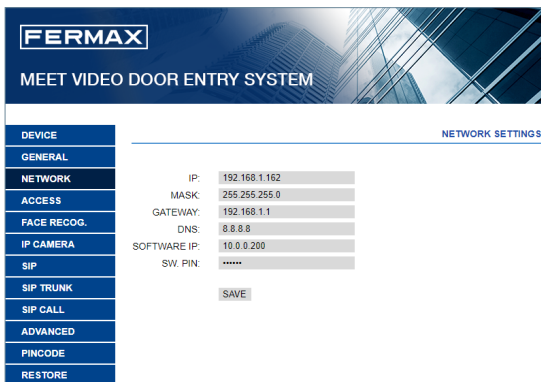

IP: IP address to be assigned to this panel.

MASK: Subnet mask corresponding to the LAN

GATEWAY: LAN gateway

DNS: DNS server address. In case of doubt, we recommend using the default value 8.8.8.8.

SOFTWARE IP: IP address of the PC where the MEET Management Software is installed (if any).

SOFTWARE PIN: PIN ACCESS code for the Management Software control. The default setting is 123456. Indicate the corresponding parameters and click on SAVE to confirm.

NOTE:

The MEET system uses static IP addressing. This ensures that each device has a unique IP address in the same installation.

If a device has an IP address already assigned to another device on the network, an “IP CONFLICT” prompt will appear, along with the MAC of the conflicting device. Both devices will not work properly until this issue is resolved.

2.4. ACCESS

This section allows some programming related to the access control functionality of the panel.

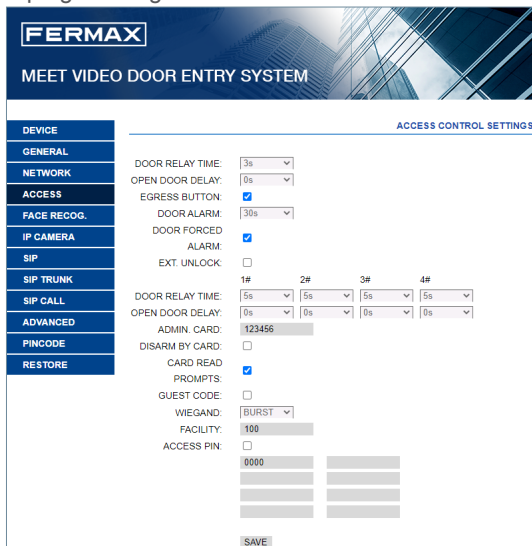

DOOR RELAY TIME: Time for lock-release relay remains active (1-9s optional).

OPEN DOOR DELAY: The time that the open-door command has be sent and the relay is not activated. The relay will activate after the DOOR DELAY TIME be set, Open door relay is useful when the door is not close the panel. (option 0-9s).

EGRESS BUTTON: The egress button will available if the EGRESS BUTTON is be checked,the relay of panel and Ref.1490 will be activated if the egress butto is be activated.

DOOR OPEN ALARM: An alarm will trigger if the door keeps opened after the programmed DOOR ALARM time. Options: disable, 30s. 60s. 120s, 180s and 250s.

DOOR FORCED ALARM: An alarm will trigger if an abnormal way to open the door has been detected, for example because there has not been any previous “open the door” command.

EXT. UNLOCK: Activates Only available in panel programmed as PANEL 1. It activates or deactivates the additional relay performance.

A module Ref. 1491 (4 relay module) must be connected to the RS485 port of the panel No.1. See INSTALLATION section for further details.

- **1-4 DOOR RELAY TIME:** Time that the corresponding additional door relay keeps active (1-9s optional).
- **1-4 OPEN DOOR DELAY:** The time that the open door command has be sent and the relay is not activated. The relay will activate after the DOOR DELAY TIME be set, Open door relay is useful when the door is not close the panel. (option 0-9s)

ADMIN CARD: Master card registered to enrol additional prox cards. When there is no management software enter 0000 if you do not know the ID of the admin card. The first prox card detected by the reader will act as admin/master card the card of resident can be added afterwards. If this method is used, register the resident proximity id numbers on the cards.

DISARM BY CARD: When an already programmed user card is presented to the reader, and it has been previously assigned to a monitor, the alarm system of the corresponding apartment will change to HOME mode.

CARD READ: To disable, no tips when the panel read unauthorized card.

GUEST CODE: Guest code function can be enabled or disabled. The panel needs to be connected with a module Ref. 1494 to a third party Access Control System. See INSTALLATION section.

WIEGAND Protocol used for Wiegand transmission (BURST or 26 BITS). Enter available parameter depending on the third-party Access Control System

FACILITY: Enter available parameter depending on the third-party Access Control System.

ACCESS PIN: To enable or disabled the activation of the relay for ACCESS PIN code. UP to 8 different PIN codes per panel. PIN length between 4 to 6 digits.

2.5. FACE RECOGNITION

Use this setting to enable or disable the FACE RECOGNITION function of the panel.

The FERMAX MANAGEMENT SOFTWARE V01.05 is required for programming and managing the photos of the authorized faces if the model is 5.0.

The FERMAX MANAGEMENT SOFTWARE V01.06 is required for programming and managing the photos of the authorized faces if the model is 6.0.

FACE RECOGNITION:

FACE RECOGNITION:

AUTO ACTIVATION:

MODEL:

LIVENESS DETECTION:

SIMILARITY:

SAVE

FACE RECOGNITION:

Enable or disabled face recognition function.

AUTO ACTIVATION:

Enable or disabled face auto activation function. If enable, Wait 15 seconds for any process to end.

MODEL: 5.0, 6.0 options.

LIVENESS DETECTION:

Enable or disabled LIVENESS DETECTION function.

SIMILARITY:

High, medium and low options. Default is low.

NOTES:

MEET panel face recognition function is based on a bidimensional face identification, with the ability of differentiating among photos or live faces in certain conditions.

This technology can be used to open doors but cannot guarantee the highest security level or 100% accuracy of liveness detection.

2.6. IP CAMERA

The monitor can switch to IP CCTV camera video during a conversation. This function allows to configure IP CCTV cameras using RTSP protocol to be displayed as an auxiliary camera to provide different view angles from the door or related areas.

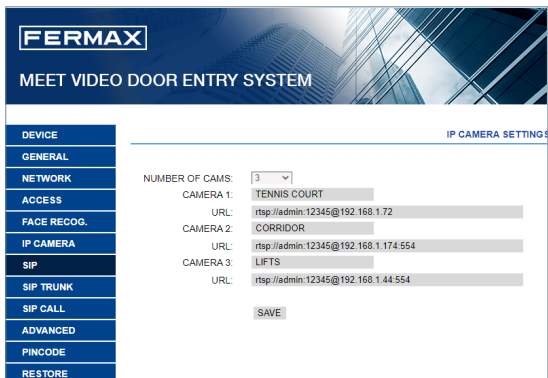

NUMBER OF CAMS: IP camera Number. Up to 4 different cameras.

- CAMERA 1, 2, 3 and 4: IP camera name.
- URL: -> **rtsp://user:password@ip_adress_of_camera.**

User:password: for cameras that require a username and password for connection. Depending on the brand/model of camera, other URL different than the one above would be required. Check the IP camera technical documentation.

2.7. SIP

This option allows configure KIN panel for use SIP functionalities, such us smartphone divert using the FERMAX MEET-MEE APP or allow the panel to operate with a third-party SIP systems or terminals using SIP protocol instead of FERMAX MEET protocol.

Configuration for smartphone call divert, using FERMAX MEET ME APP

Configure the SIP parameters as explained below, if the divert function to smartphone, trough the FERMAX MEET ME server is used.

ENABLE SIP: Select this box to enable SIP functions.

SEARCH SIP STATUS: This button appear when enable SIP fuction, show SIP REGISTERED if the panel register successfully or SIP REGISTER FAILED if the panel register unsuccessfully.

SIP SERVER: Use the FERMAX MEET server ->

sip: sip.fermax.com.

DOMAIN: Indicate the server domain -> **sip.fermax.com**

OUTBOUND: Not necessary. Leave it in blank.

STUN IP: Not necessary. Leave it in blank.

STUN PORT: Not necessary. Leave it in blank.

H.264: Leave the default value: 102

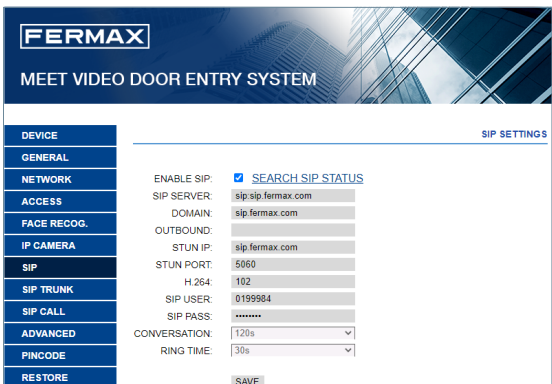

SIP USER, SIP PASWORD: Indicate the user and password of the FERMAX MEET ME licence assigned to this panel. They are indicated in a label attached in the front of the panel.

CONVERSATION, RING TIME: No function.

Configuration for SIP server integration

Configure the SIP parameters as explained below, for the cases where the KIN panel works as an extension of a SIP server.

Contact with the SIP server administrator to get some of the information required in this section.

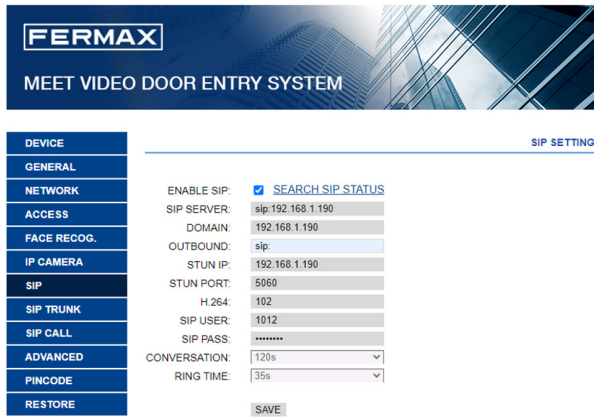

ENABLE SIP: Select this box to enable SIP functions.

SEARCH SIP STATUS: This button appear when enable SIP function , show SIP REGISTERED if the panel register successfully or SIP REGISTER FAILED if the panel register unsuccessfully.

SIP SERVER: Indicate the sip SERVER address. Format -> sip: IP_SERVER.

DOMAIN: domain of the SIP server or IP address.

OUTBOUND: Not necessary. Leave it in blank.

STUN IP: domain of the SIP server.

STUN PORT: Used for the configuration of Internet SIP server-based installations. It is usually port 5060. Check with your network or SIP server administrator.

H.264: Depends on the SIP SERVER. In the case of doubt, leave the default value.

SIP USER, SIP PASSWORD: Indicate the user and password that this terminal is programmed in the SIP server.

CONVERSATION, RING TIME: No function.

2.8. SIP TRUNK

When there is a VoIP gateway installed on the network connected to a PSTN line.

The panel call can be diverted to user’s mobile phone or land line telephone through a voice gateway.

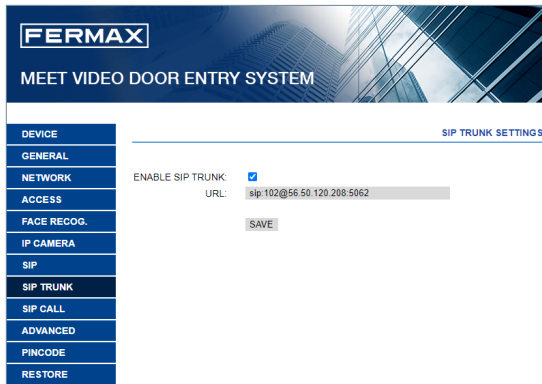

ENABLE SIP TRUNK: Enable or disable SIP trunk function.

URL: URL of the device:

Format

sip:sip_trunk_account @sip_trunk_domain:port

or

sip:sip_trunk_account@sip_trunk_ip:port

2.9. SIP CALL

This option allows to generate calls to smartphone devices in the cases where is not a MEET monitor associated in the installation. A FERMAX MEET ME licence Ref.1496 is required for each apartment. The call can be received in 8 smartphones simultaneously.

Furthermore, it is also possible, to generate simultaneous calls to several devices MEET and/or third-party SIP devices as well, using SIP protocol instead of FERMAX MEET protocol.

A csv file containing the associated number and the information of the diverted device or devices must be updated in the panel.

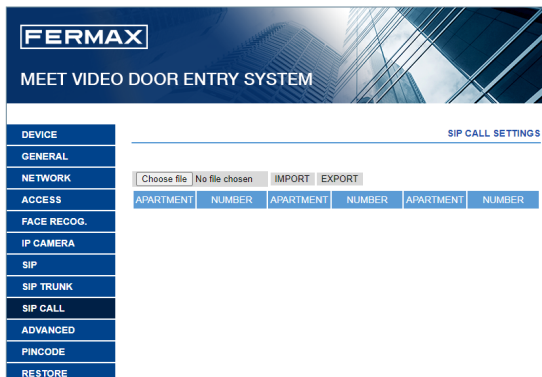

The operation procedure to generate and update the .CVS file is as follow:

1. Select EXPORT to generate a blank .CVS table, and save it in your PC. Rename this table as your choice or leave the default name (MEET CALL DIVERT PXXX-YY.csv), where XXX is the BLOCK NUMBER and YY is the device number assigned to this panel).
2. Use Microsoft Excel to open the created file. It will look like:

A	B	C
APARTMENT, NAME		

3. The first cell (A1) has the content: APARTMENT, NAME, Do not change it.
4. Use the following cells (A2, A3, A4, etc.) to fill in the data of the devices to divert. Depending on the type of call, the format of the data is different:
 - a. IN the case of a call to a **FERMAX MEET ME LICENCE**: APARTMENT, sip: **XXXXXX@sip.fermax.com** where XXXXXXX is the licence name and APARTMENT is the number to dial in the panel.
 - b. IN the case of a call to a **MEET** device in the same installation: APARTMENT, **sip:XXX@IP_DEVICE** where XXX is any identifier of the device and IP_DEVICE is the IP address to the MEET monitor to call.
 - c. In the case of a call to a third party SIP device (through a SIP server): **APARTMENT, sip:user@IP_SIP_SERVER** where user is the identification user that the device to call has been programmed in the SIP server, and IP_SIP_SERVER is the SIP server IP address.
 - d. It is also possible to assign multiple and different divert formats to the same apartment (for example a call to a third-party SIP device and a smartphone device as well).Use the corresponding format explained above, using the same row but different column for each format. See example below.
5. Once the table has been finished, save it and IMPORT to the panel. For this, click on "Choose file", select the file to import and click on IMPORT button. Wait for a few seconds until a pop up message "UPLOAD SUCCESS" appear.

Note: The maximum number of items in the list is 1000.

6. EXAMPLE

	A	B	C	D
1	APARTMENT, NUMBER,			
2	170,sip:170@192.168.1.190			
3	171,sip:0103283@sip.fermax.com			
4	645,sip:645@192.168.1.195			
5	180,sip:1234@192.168.1.170			
6	181,sip:1234@192.168.1.170	sip:0103283@sip.fermax.com		
7	182,sip:1234@192.168.1.170	sip:170@192.168.1.195		
8	183,sip:1234@192.168.1.170	sip:172@192.168.1.197	sip:0103283@sip.fermax.com	
9				
10				
11				
12				
13				
14				

In this example:

- Apartment 170 generates a call to the monitor IP 192.168.1.190 in the same installation.
- Apartment 171 generates a call to the smartphone with FERMAX MEET ME licence 0103283.
- Apartment 645 generates a call to the monitor IP 192.168.1.195 in the same installation.
- Apartment 180 generates a call to the SIP device 1234 of the SIP server with IP 192.168.1.170.
- Apartment 181 generates a call to the SIP device 1234 of the SIP server with IP 192.168.1.170 and to the smartphone with FERMAX MEET ME licence 0103283.
- Apartment 182 generates a call to the SIP device 1234 of the SIP server with IP 192.168.1.170 and to the monitor IP 192.168.1.195 in the installation.
- Apartment 183 generates a call to the SIP device 1234 of the SIP server with IP 192.168.1.170 and to the monitor IP 192.168.1.197 in the installation and to the smartphone with FERMAX MEET ME licence 0103283.

2.10 ADVANCED

Some advanced settings, such as quick dial and directory, can be selected in this section.

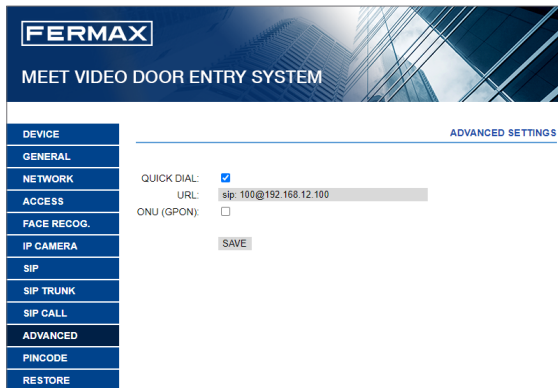

QUICK DIAL: When the panel is working in 1W KEYPAD, it is possible to use the call pushbutton in the panel to directly call to a specific device (monitor, SIP telephone, smartphone running FERMAX MEET ME APP).

URL: Indicate the device that has to receive the call, with the corresponding format:

- Another monitor -> **sip:@IP_monitor**
- SIP device: -> **sip:user@IP_SIP_server**
- FERMAX MEET ME device -> **sip:meet_me_user@sip.fermax.com**

ONU (GPON): Used in large installations based on SIP protocol (GPON) and in combination with the configuration of said installations.

2.11. PINCODE

It allows you to change the INSTALLER PIN code, to access both the installation configuration parameters through the monitor's own screen and the configuration through a web browser.

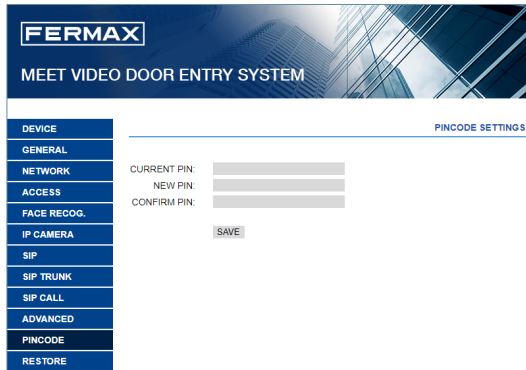

The screenshot shows the FERMAX web interface for the 'MEET VIDEO DOOR ENTRY SYSTEM'. On the left is a vertical navigation menu with the following items: DEVICE, GENERAL, NETWORK, ACCESS, FACE RECOG., IP CAMERA, SIP, SIP TRUNK, SIP CALL, ADVANCED, PINCODE, and RESTORE. The 'PINCODE' item is highlighted. The main content area is titled 'PINCODE SETTINGS' and contains three input fields: 'CURRENT PIN:', 'NEW PIN:', and 'CONFIRM PIN:'. A 'SAVE' button is located below the input fields.

Enter the current code, the new pin and confirm it.

The new password can have alphanumeric characters and has no limit on its length.

Finally, select SAVE.

NOTE:

Make a note of the new PIN at your convenience. If you lose or forget your PIN, you should contact FERMAX's Technical Department to receive instructions regarding its recovery. All settings programmed into the panel will be lost after recovery.

2.12. RESTORE

Use this functionality to remotely reset the MILO panel, or to return it to factory settings. In both cases it will ask for confirmation.



The screenshot shows the FERMAX web interface for the 'MEET VIDEO DOOR ENTRY SYSTEM'. On the left is a vertical navigation menu with the following items: DEVICE, GENERAL, NETWORK, ACCESS, FACE RECOG., IP CAMERA, SIP, SIP TRUNK, SIP CALL, ADVANCED, PINCODE, and RESTORE. The 'RESTORE' item is highlighted. The main content area is titled 'RESTORE' and contains two options: 'RESTORE FACTORY SETTINGS' and 'REBOOT DEVICE'. Each option has an 'OK' button next to it.

RESTORE FACTORY SETTINGS: The panel will automatically turn off and start up with the factory settings. We refer below the essential parameters for your reference.

GENERAL

- BLOCK: 1
- DEVICE: 1
- LANGUAGE: ENGLISH
- VIDEO RESOLUTION: 640 x 480

NETWORK

- IP: 10.1.0.1
- MASK: 255.0.0.0
- GATEWAY: 10.254.0.1
- DNS: 8.8.8.8
- SOFTWARE IP: 10.0.0.200

Any other parameters (sip, IP cameras, concierges, etc.) that have been configured will also be lost.

REBOOT DEVICE: The panel will automatically turn off and start up but retain all the programming parameters it had previously.

When resetting, the device will lose connection with the PC. Refresh the website after about 60 seconds to resume the connection.



OPERATION

Interaction with MILO panel is through a keypad. In the case of Ref. 9531 it is a mechanical keypad, and in the case of Ref. 9532 it is a touch keypad.

Operation is the same, independently of the type of keypad

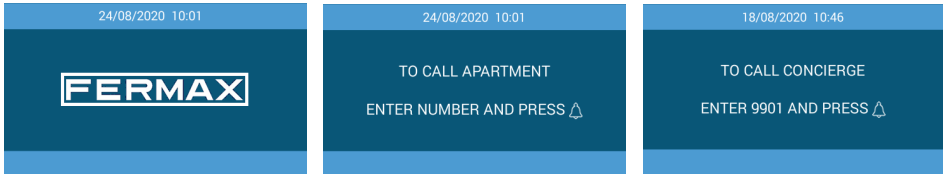

A TFT screen allows basic information for the users, alternating information of how call apartments and how call concierge.

This screen is usually in off state, to save energy, but it turns on automatically at the moment that someone stands in front on the panel or touches any button of the keypad, and turns off again after 60 seconds since the last operation.

Calling to Apartments

Users shall use the keypad to dial the apartment number followed by the “bell” button. If the panel has been configured as BLOCK PANEL, users have to enter the apartment number (1 to 4 digits) only.

If the panel has been configured as GENERAL ENTRANCE PANEL, users have to enter the block number (1 or 2 digits) followed by the apartment number (4 digits).

Dial “A” to cancel a call, for example because you are entered the wrong number.

Example:

- Call to apartment 46 from a BLOCK PANEL: 46 + “bell”
- Call to apartment 103 of the block number 6 from a GENERAL ENTRANCE: 6-0103 + “bell”

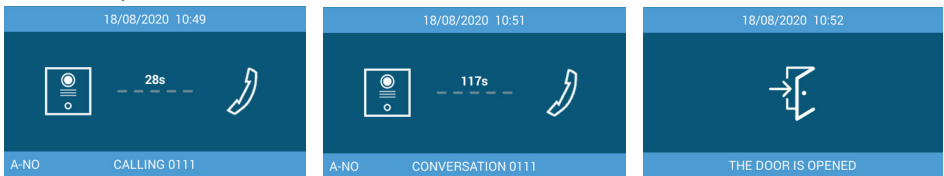

The screen indicates the called apartment and the remaining time.

After 30 sec. the call is cancelled if it is not answered.

Once the call is answered, the screen indicates the remaining talking time.

After 120 sec the call ends (if it is not cancelled from the apartment)

A speech “The door is open”, please close the door behind you” is heard at the moment that the door has been opened from the called apartment.

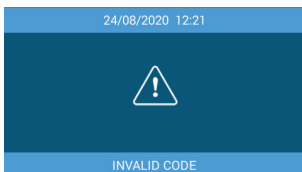

INEXISTENT NUMBER indicates that the called number does not exist or you have dialled the wrong number.

Face Recognition

This function allows users to be identified by means of facial recognition. Someone stands in front on the panel if auto activation enable or dialling “A” twice the face recognition interface will appear. If the user’s face has been programmed and the system recognizes him, the door will open.

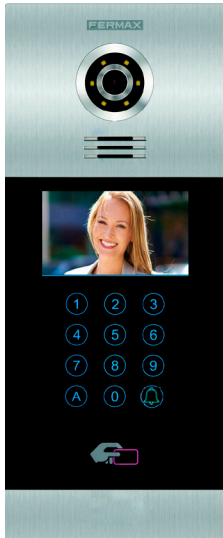

The person has to stay in front of the panel for a few seconds.

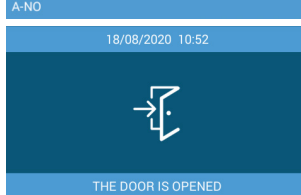

If the user is recognized, the door will open.

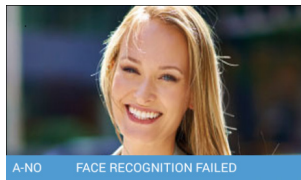

FACE RECOGNITION FAILED indicates that the systems does not recognize the person.

NOTE:

Face recognition requires some previous programming by means of the FERMAX MEET MANAGEMENT Software.

Access Pin

This function allows users open the door by means of entering an ACCES PIN code. Dial “A0” to enter in PIN CODE mode:

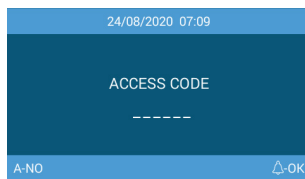
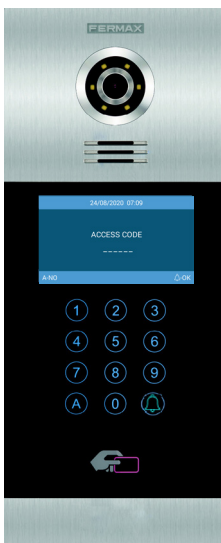

Users shall enter the correct PIN CODE followed by “bell”. To cancel, just dial “A”

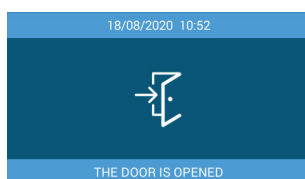

If the PIN is correct, the door will open

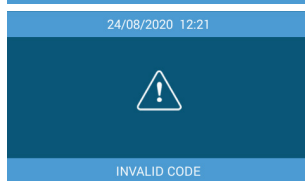

INVALID CODE
The entered code is not valid.

The panel admits up to 8 different ACCESS PIN CODE, that must be programmed by the installer. Length of each ACCESS PIN CODE could be between 4 to 6 digits. See WEB BROWSER PROGRAMMING section for further details

Guest Code

This function allows users open the door by means of entering a numerical code that has been given to him, for example to get access during a certain day.

The panel shall have installed a GUEST CODE MODULE Ref.1494 and a third-party Access Control System is required.

Dial “A7” to enter in GUEST CODE mode:

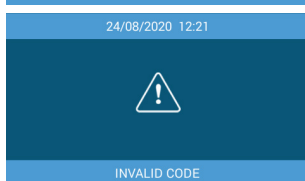
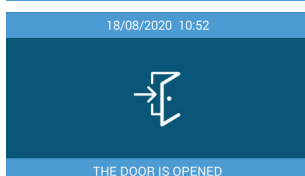
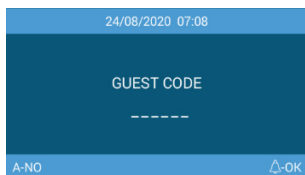
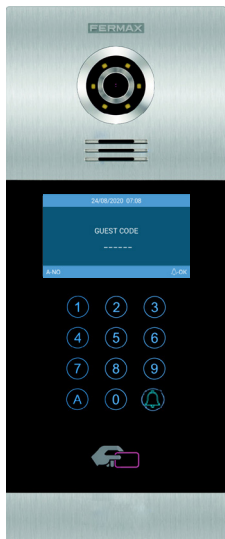

Users shall enter the correct GUEST CODE followed by “bell” button.

If the CODE is correct, the door will open

INVALID CODE
The entered code is not valid

On screen information

It is possible to get basic information on the equipment configuration through the screen

Dial “9999” followed by “bell” button.

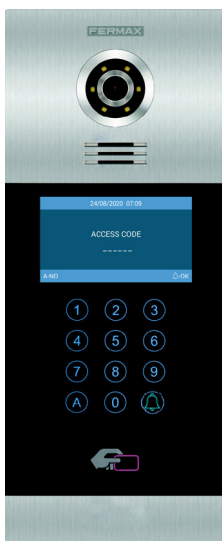

The screen will display information about panel settings:

- Firmware version
- GENERAL settings
- Serial number
- IP address
- MAC



INSTALLATION

4.1 FLUSH BOX INSTALLATION

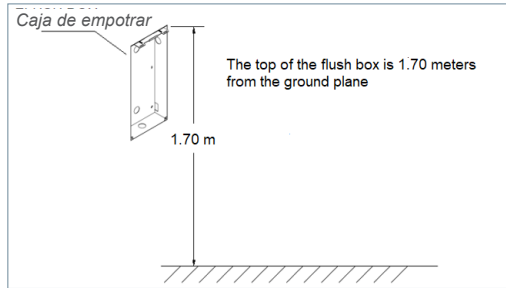

4.2. INSTALLATION GUIDE DIAGRAM

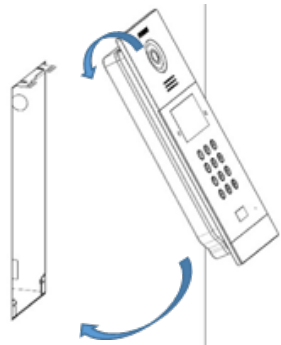

1 Flush box install.

2 Base flush box depth adjustment hook.

3 The upper part of the panel is stuck in, then move the panel to the flush box.

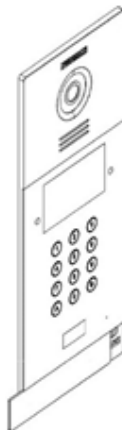
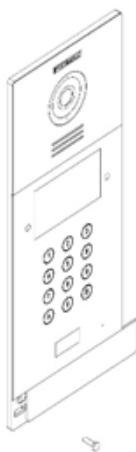

4 Move the slider of the panel and fix the two screws. When installing, pay attention to the reservation of the 2 cm space around the door to move the slide cover.

4.3. CONNECTORS

The MILO panel is connected to the installation by means of connectors: ethernet for LAN connection and MOLEX type connectors for other connections (power supply, RS-485, etc.). A bag containing the corresponding female connectors with their cables comes with the panel.

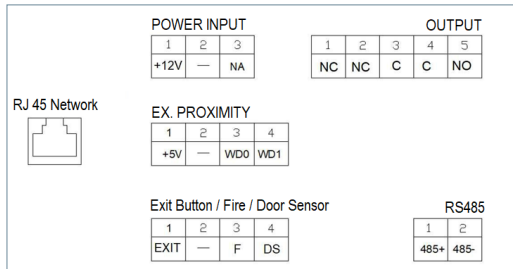

POWER INPUT: 12 Vdc power supply.

OUTPUT: Electric lock control relay output.

- NC: Normally closed contact.
- NO: Normally opened contact.
- C: Common.

NOTE: NC & C contacts are internally duplicated.

EX PROXIMITY:

- (WD0-WD1) Wiegand input/output.
- (+5V, -) 5 Vdc auxiliar output.

Exit Button /Fire / Door Sensor. See NOTES.

- (EXIT, -) Connections for indoor button.
- (F, -) Input for fire alarm & block doors unlock contacts.
- (DS, -) Connection for door opened sensor.

RS485

- Output for Ref. 1491/Ref. 9545 MEET LIFT Control Gateway, Ref. 1494 Guest code or Ref. 1490 External Relay (*).
- (*) Ref. 1490 works in this case as a repeater of the internal relay of the panel.

RJ 45 Network

- RJ 45 LAN.

NOTES:

EXIT, FIRE and DS require installer programming. See WEB BROWSER PRORAMMING for further details.

EXIT button allows users to open the door from inside.

FIRE input in PANEL N° 1 has to be connected to a fire output relay of a third-party fire alarm system. If a fire alarm is triggered, an alarm will sound in all the panels of the block, and all the doors will remain opened.

Installing a door open sensor in DS, an alarm sounds in the panel and concierge if the door remains opened during a programmed period, or the door has been forced as well.

The panel has an internal tamper button. If the panel is separated from the wall, an alarm is triggered in the panel, concierge and FERMAX MANAGENEMN SYSTEM (if exists).

4.4. BASIC DIAGRAMS

Supply the panel by means of a FERMAX Ref. 4813 (18 Vdc 2A) power supply

Use a power supply adapted to the electric lock voltage & current. Do not power the panel and the electric lock from the same power supply.

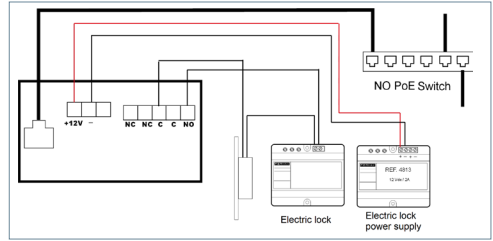

4.5 INSTALLATION OF THE 4 RELAY MODULE REF. 1491

This module is necessary if you want to use the facility of activating from the monitors additional relays (up to 4), for example to activate additional doors or gates.

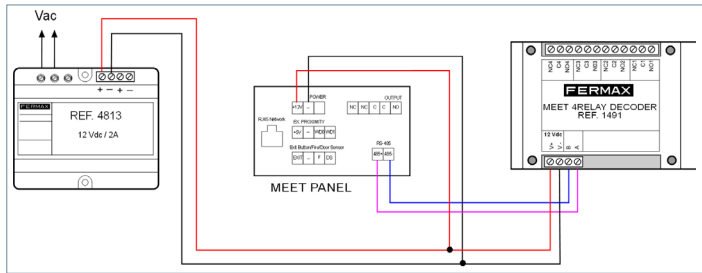

NOTE:

The 1491 module need be connected to the PANEL No.1 in the block. The decoder RS485 address need be set to number 2 (factory defaults is 2). If you need read and write the address 1491, please run the software MODBUS RTU ADDRESS CONFIG TOOL.exe.

4.6. DIAGRAM INSTALLATION OF THE GUEST CODE MODULE REF. 1494

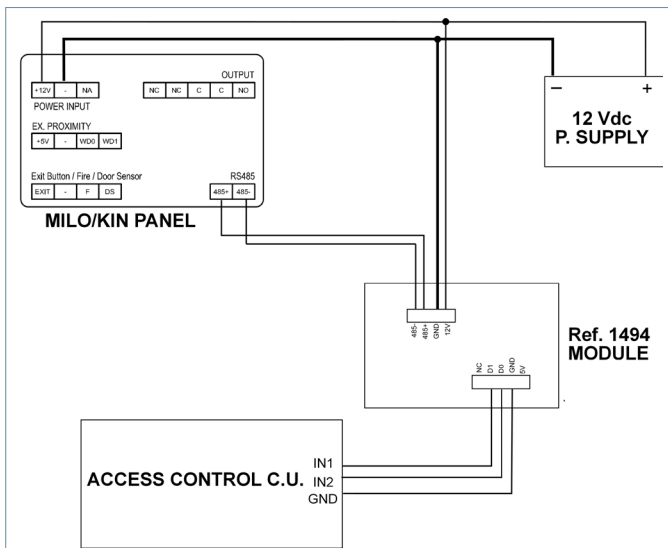

4.7. DIAGRAM INSTALLATION OF THE LIFT CONTROL SYSTEM

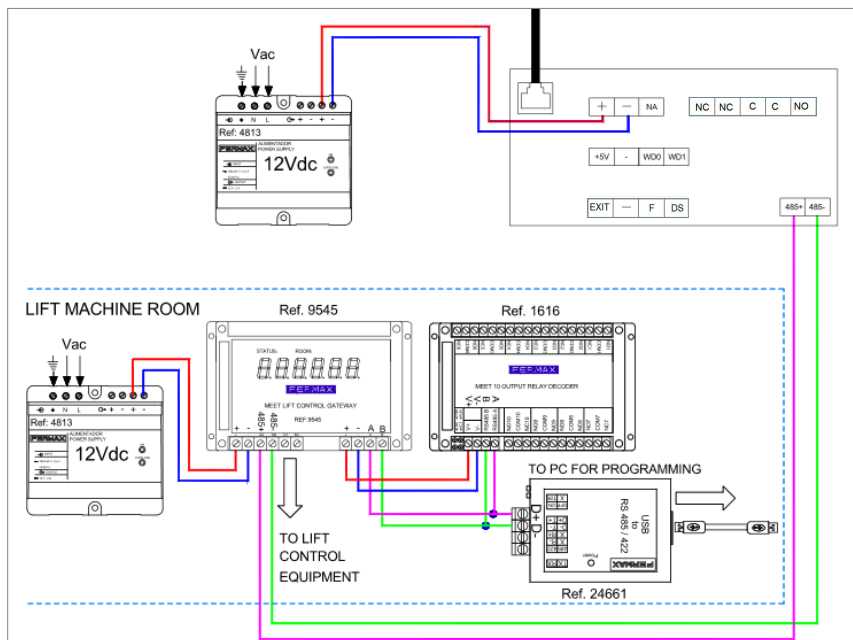

This installation has to be performed in the PANEL n° 1 of the corresponding block only.



5 TECHNICAL SPECIFICATIONS

Power supply	12 Vdc
Standby current	250 mA
Working current	500 mA
Display specifications	
Size	4,3"
Format	4:3
Resolution	480*272
View angle	110° (H), 90° (V)
Contrast	400/1
Brightness	200 cd/m ²
Audio Features	
Codec	G. 711
Audio	OLR >15dB
Cámara	
CMOS	colour 1/3"
View angle	72° (H), 54° (V)
Resolution	1,2 Mega Pixel
Minimum Illumination	0,5 Lux Automatic white led activation
AWB	
Working Environment	
Temperature	- 40°C + 70° C
Humidity	20-80% (Non-condensing)
IP	54
Maximum conversation time	disable,30s,60s,120s,180s,250s
Door relay time	1-9s
Door delay time	0-9s
Door sensor time	120s
IC cards	100.000 cards
Face data	6.000 faces

6.1. FIRMWARE UPDATES

Sometimes it may be necessary or convenient to update a new firmware version because improvements or corrections have been incorporated into its operation.

FERMAX's Technical Department periodically informs (through Communications, Technical Bulletins, etc.) about the release of a new firmware update, as well as the improvements incorporated.

Contact the FERMAX Technical Department if you wish to receive the corresponding update file.

The firmware update is performed via the **FERMAX MEET System Upgrading Tool V01.00.exe**. The procedure for updating the firmware with the corresponding update file is as follows:

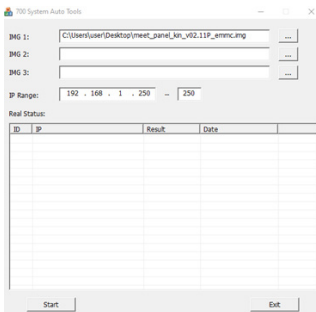

1. Start the **FERMAX MEET System Upgrading Tool v1.00.exe**.
2. Browse the PC to find the location of the corresponding update file
3. Indicate the IP of the monitor
4. Select Upgrade.

The new firmware will be installed, and the panel will automatically restart.

6.2. REGULATIONS

Radio frequency module. Ec Declaration of Conformity:

FERMAX ELECTRÓNICA, S.A.U. declares that this product complies with the requirements in the RED

2014/53/EU Directive “Radio frequency equipment”.

<https://www.fermax.com/intl/en/pro/documents/technical-documentation/DT-13-declarations-of-conformity.html>

Radio frequency module:

- Frequency: 13.56MHz / Maximum Power: 2,45mW.

This equipment has been tested and found to comply with the limits for a Class B digital device, pursuant to Part 15 of the FCC Rules. These limits are designed to provide reasonable protection against harmful interference in a residential installation. This equipment generates, uses, and can radiate radio frequency energy, and if not installed and used in accordance with the instructions, may cause harmful interference to radio communications. However, there is no guarantee that interference will not occur in a particular installation. If this equipment does cause harmful interference to radio or television reception, which can be determined by turning the equipment off and on, the user is encouraged to try to correct the interference by one or more of the following measures:

- o Reorient or relocate the receiving antenna.
- o Increase the separation between the equipment and receiver.
- o Connect the equipment into an outlet on a circuit different from that to which the receiver is connected.
- o Consult the dealer or an experienced radio/TV technician for help.



6.3. OUTDOOR PANEL VIDEO STREAMING

Using an external device (PC/Smartphone/Tablet) connected to the network it is possible to play the video from the Panels using the following rtsp address:

```
rtsp://admin:password@Panel_IP:8554/ch01
```

admin: admin

password: 123456 (Default), if it hasn't been changed.

Panel_IP: La IP Actual de la placa de calle.

It is possible to use a video player that supports video streaming like the picture below:

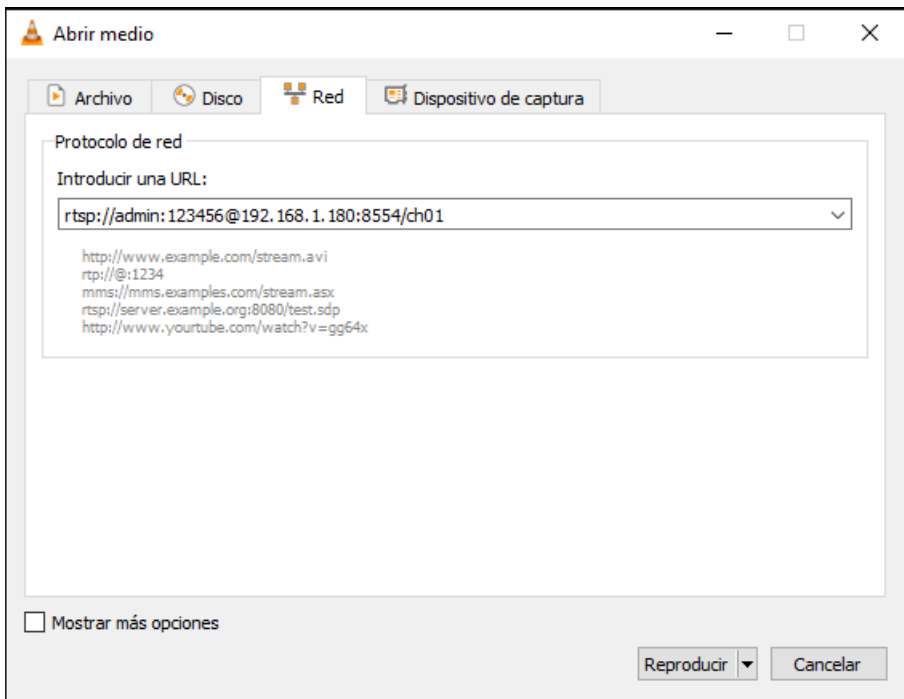



Avd. Tres Cruces, 133
46017 Valencia
Spain

For more information, visit www.fermax.com

Contact: tec@fermax.com / www.fermax.com/contact