



AUTONOMOUS PROXIMITY READER DESFIRE

FERMAX

INSTALLATION MANUAL



CONGRATULATIONS ON YOUR PURCHASE OF THIS QUALITY PRODUCT!

Fermax develops and manufactures systems of renown that meet the highest standards of design and technology. We hope you enjoy its range of functions.

Technical information booklet published by FERMAX ELECTRONICA.
As part of its policy for constant improvement, FERMAX ELECTRONICA reserves the right to modify the content of this document and the characteristics of the products referred to therein at any time and without prior notice.
Any modification will be reflected in subsequent editions of this document.

INSTALLATION MANUAL

TABLE OF CONTENTS

Introduction.....	4
Wiring Diagrams	6
Connection Grid.....	7
Technical Features /Default Values	7
Autonomous System Operating Modes.....	8
- Activating the Card Reader	8
• MASTER Card Reset	8
-Activating Personal Cards.....	9
-Deactivating Personal Cards.....	10
-Adjusting the Door Opening Time	11
-Adjusting the Time the Door is Open	12
-Copying	13
- PC Management	15

INTRODUCTION

The AUTONOMOUS proximity reader can control up to 400 cards. Each of these cards, which operate without any type of maintenance, is equipped with a unique electronic code (there are no two cards with the same code).

FERMAX Desfire readers include an encryption system to guarantee the security of the installation (please consult with the Technical Service). Reader encryption is done by the distributor and the following equipment is necessary for you, as the installer, to encrypt the identifiers (cards and key fobs):

- PC with Desfire Security Programmer software.
- Desktop programmer to encrypt readers, encrypt cards and read card identifiers. Part number F04534.
- Desktop reader to read the card identifiers. Reference F04533.

Once activated, you can use them to open the relevant access door. To this end, it is simply necessary to swipe (momentarily approximate) the card to the proximity reader.

As it operates on a radio frequency, no physical contact is necessary, meaning you can even swipe the card without taking it out of your wallet. The maximum reading distance is 2 cm.

For more details on encryption, see manual 970210 Desfire Software. The proximity reader has various light indicators, the meaning of which is the following:

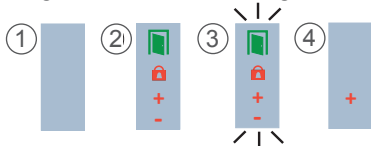

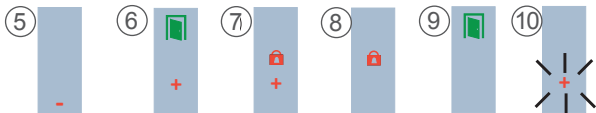

1. No Power.
2. Reader Deactivated. The MASTER card has not been activated as yet.
3. Changing MASTER Card Mode
4. Card Activation Mode:
5. Card Deactivation Mode:
6. Lock-Release Activation Time Configuration Mod.
7. Door Open Time Configuration Mode
8. Normal Mode. Door Closed.
9. Normal Mode. Door Open.
10. Overload. The user is attempting to activate more than the 400 cards permitted.



Swiping a registered card by the reader the door will open and the green led will light up. A confirmation «beep» will be emitted.



Swiping an unregistered card by the reader the door will not open nor will the green led light up. A «double beep» will be emitted indicating that access has been denied.

To use personal proximity cards, the proximity card reader must be activated.

CONNECTION DIAGRAM FOR AUTONOMOUS READER (Class I)

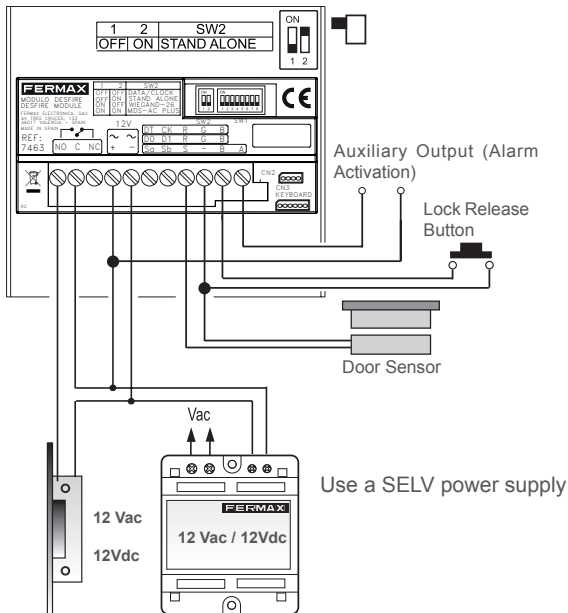

CONNECTION GRID

- **+**, **- / ~**, **≐**: Power Supply (12 Vdc / 12 Vac).
- **C**, **NO**, **NC**: Lock-release relay output (potential free).
 - **C**: Common.
 - **NO/NC**: Normally Open/ Normally Closed.
- **SW1**: System Coding Dipswitches.
- **CN2**: Connector for PC connection or clone drive.
- **B**, **-**: Lock-Release Button.
- **S**, **-**: Open Door Detector. (It requires the installation of a magnetic door sensor).
- **A**, **-**: Output for alarm activation.
- **Sa**, **Sb**: No function.

TECHNICAL FEATURES /DEFAULT VALUES

Power supply	12 Vdc/Vac
Consumption Standby	45 mA
Active relay consumption	85 mA
Operating temperature	-15°C a + 55°C
Relative humidity	5-95% (no condensation)
IP Cityline – Marine	43 - 54
IK Cityline – Marine	07 - 09
Number of users	400
Number of master cards	1
Door Opening Time	01... 99 seconds. Programmed by default 3 seconds.
Door Sensor Timing	00 ... 250 seconds. Set by default to 0, disabled.

AUTONOMOUS SYSTEM OPERATING MODES

Activating the card reader

To activate the reader the MASTER card must be programmed. This is the card which is subsequently used to access the programming functions. The system will take the first card swiped after powering up the system to be the MASTER card.

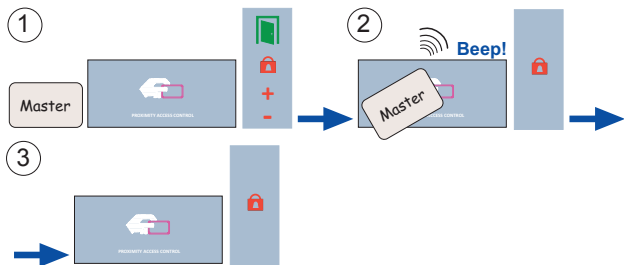

1. Set up one of the cards as a MASTER card. This card cannot be used as a personal card.
2. Swipe the card by the reader.
3. The reader is now activated and is ready to operate once the personal cards are set up.

Master card reset

If you do lose the MASTER card or if you wish to change it, you must follow the steps (we recommend that this work is carried out by specialised personnel).

1. Disconnect the power supply.
2. Press and hold the Exit Button (if installed) or make a shortcut between <> and <<->> terminals on the reader controller. Then power on.
3. The reader goes into «Changing MASTER Card Mode». All the reader's indicators start to flash for 5 seconds.

Any card swiped by the reader during this time will be taken to be the new MASTER card.

The card swiped does not have to be a card already registered as a personal card.

If the card swiped is that already set up as the MASTER two things may occur:

o If the output button remains activated it will be deleted.

o If the output button is not activated, the reader will remain configured with its factory settings: without a Master, without user cards and with the default times set.

It will be clear that the Master card and all the data has been deleted as the green indicator led will continuously flash until the power supply is disconnected.

Once reconnected, the reader will be deactivated, that is awaiting the setup of a new MASTER card.

NOTE: *The reader will return to normal mode from any programming mode if a card has not been presented within 30 seconds.*

Activating personal cards

Up to 400 cards can be activated, following the steps below.

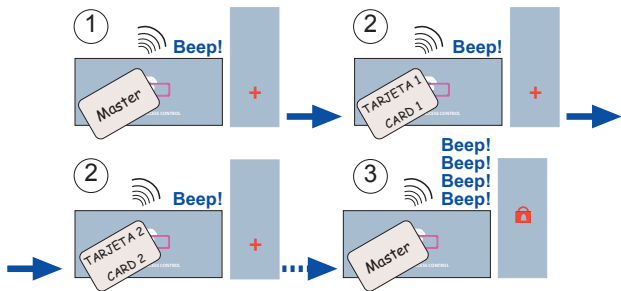

1. Swipe the MASTER card . The indicators show the user is in «Card Activation Mode».
2. Swipe all the different cards that you want to activate one after the other.
Ensure the code for each of the cards is kept in a safe place for future reference.
3. Swipe the MASTER card again once finished, until the indicators show «Normal Mode» status.

A «beep» indicates that the card has been set up correctly. Alternatively a double beep will indicate that it was already active or that the card is defective. If you attempt to activate more than 400 cards the system will indicate «overload» (the «+» indicator will flash for 5 seconds).

Deactivating personal cards

To deactivate a card on the system you must have the physical card in your possession. The procedure is the following:

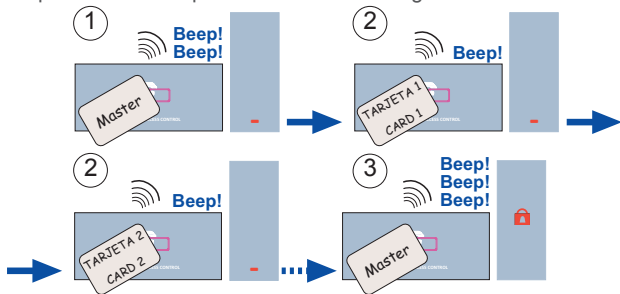

This requires that we have a list of card codes and the name of each user such that we know which card code to deactivate.

Adjusting the door opening time

This parameter can be adjusted between 1 and 99, representing the time in seconds that the lock-release is activated once a card has been setup.

1. Swipe the MASTER card (three times).

The indicators show we are in «Lock-Release Activation Time Configuration Mode».

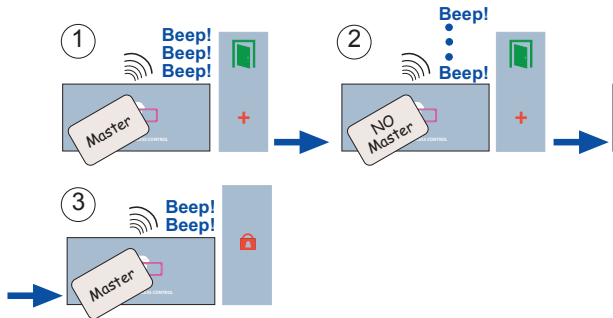

2. Swipe any card (except the MASTER card) once for every second you want the lock-release to be activated for.
Once: 1 second Twice 2 seconds.
3. Swipe the MASTER card again once finished, until the indicators show «Normal Mode» status.

Adjusting the time the door is open

This parameter adjustable to between 0 and 250, represents the time in seconds after which an alarm incorporated within the reader will begin to sound, should the door remain open. It requires the installation of a magnetic door sensor. See diagram.

Initially this function is disabled (0 value), so if you wish to enable it you must follow the steps below.

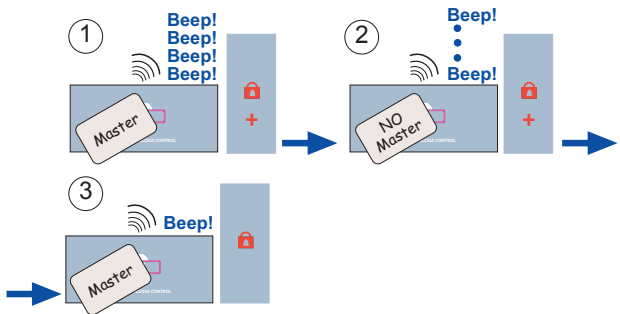

1. Swipe the MASTER card (four times). The indicators show we are in «Open Door Timing Configuration Mode».
2. Swipe any card (except the MASTER card) once for every second you want the open door detection to be set up for.
See NOTE
3. Swipe the MASTER card again once finished, until the indicators show «Normal Mode» status.

NOTE: The first time you swipe the card this option will be enabled (signifies 0 seconds). Any further swipes will increase the number of seconds it is enabled for, with one second for every swipe.

Copying

Used to copy the contents of one reader to another. Steps to follow to copy.

1. Connect the reader as indicated in the diagram. It can also be connected via the CN2 connector, with the appropriate cable.

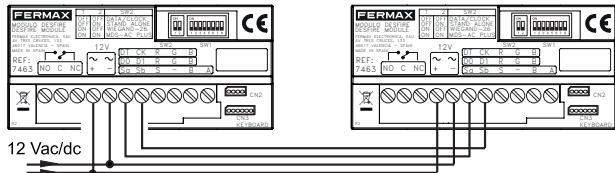

2. Code switches 6,7 and 8 on the user reader (source reader) as indicated:

SW1	6	7	8
	OFF	ON	ON

3. Code switches 6,7 and 8 on the reader to which the data is to copied (destination reader) as indicated:

SW1	6	7	8
	OFF	OFF	OFF

NOTE:

- The users' cards, opening times and door sensor options will be copied onto the destination reader.
- The Master card (on the destination reader) should be set up by the installer the first time the reader is connected.

Led operation during copying:

The reader leds indicate the status of the copying process.

Source reader

1. Copying.



Destination reader

1. The «padlock» led will flash on entering copying mode.



2. The «+» led flashes on detecting the source reader and starts to copy the users.



3. The «padlock» and «+» leds flash once the data copying is complete.



PC Management

Programming (activation, deactivation) of cards can also be done from a PC with the help of the WINPROX programme developed by FERMAX. You can only manage a reader via a serial port. See the corresponding installation manual.

If using the «Winprox» PC software, code switches 1 to 5 to ON.

SW1	1	2	3	4	5
	ON	ON	ON	ON	ON

The device you have purchased is identified under Directive 2012/19/EU on waste electrical and electronic equipment. More info:



CE Conformité
Européenne

FERMAX